

Newark Flat Crossing Renewal

BACKGROUND

Newark flat crossing is a junction on the East Coast Mainline (ECML 120ml 63ch) just north of Newark Northgate station that intersects the Newark to Lincoln line (NOB1 17ml 74ch). See image 1.

The junction is unique in that it comprises of eight double star crossings that allow the two tracks of each line to cross each other. The angle of the crossings is 44°. There are no switches at the junction allowing trains to transfer from one track to another.

The crossings are supported by a matrix of eight interlinked longitudinal bearers, each 16 m in length and 350 mm deep. The bearers of the original layout were made from 'green heart' timber, which is a very hard and dense wood that was considered to be the wood that would provide the best performance for the layout at the time of the previous renewal in 2003.

CROSSING REPLACEMENT 2015

The previous renewal carried out in 2003 had installed crossings with an unusual direct fastening system.

The crossing foot was manufactured so that the LSA screws were installed at an angle of 1 in 20 to the vertical plane, as shown in figure 1. It was thought that having two screws on opposite sides of the casting inclined at this angle toward the centre of the casting would provide a more secure method of 'pinning' the castings in position and therefore prevent lateral movement of the crossings occurring. The holes that were drilled in the crossing foot were larger than the corresponding screw shank by some margin. This gap was filled by using a nylon ferrule. Over time the lateral forces applied to the crossings through to the fastening system crushed and wore away the nylon ferrules. This allowed lateral movement to develop at the interface between the crossing foot and the screws.

By 2014 45% of the screws in the whole layout of Newark flat crossing had broken. These could not be repaired because the density of the greenheart timber that the bearers were made from made it almost impossible to remove the broken screws.

I got involved with Newark flat crossing at this point to lead the work to resolve the crossing foot design problem. This was redesigned in 2015 to have a vertical screw with an eccentric steel ferrule (figure 2) to allow for the possibility of screw holes being drilled off centre to the crossing foot hole centre. To avoid the screw holes of the new crossings clashing with broken screws still in place in the bearers from the old crossing screws, the position of the holes in the cast crossing foot were offset by 50 mm.

EXPLOSIVE DEPTH HARDENING (EDH)

The crossings in this junction are subjected to some of the highest impact forces on the network due to their design. It was decided to use EDH for the replacement crossings as part of the redesign to reduce the plastic deformation of the nose and wing rails during the initial bedding in of the crossings.

The EDH process involves laying a thin layer of explosive on the area to be hardened (image 2) and detonating it. This has the effect of compressing and hardening a thin layer of the crossing surface. This hardening helps reduce the amount of plastic deformation that occurs on austenitic manganese steel (AMS) crossings during the initial running of traffic over them. The running surface of AMS crossings is relatively soft until some traffic tonnage has run over it. The area of the double star crossings where EDH was used was restricted to the crossing nose and wing rail of the wheel transfer area. Increasing this for all running surfaces would have risked damaging or destroying the casting during the EDH process.

The revised crossings were installed in 2015 and since then no fastener failures have been reported.

2019 NEWARK FLAT CROSSING RENEWAL

At this point you may be asking yourself, "Ok that's great, but what has that got to do with the 2019 renewal?"

When I found out about the plan to renew the whole layout I was surprised because all the crossings had only been replaced three years previously. They were running well with the implementation of a regular crossing inspection regime to assess the condition of the crossings and carry out any repairs necessary.

The renewal was planned to be like for like. This would mean using the same greenheart (or similar) timber bearer construction. This would have been a nightmare in waiting for maintenance as the previous problems of broken screws would potentially reoccur leaving this impossible to maintain. This clearly would not have improved the RAMS (reliability, accessibility, maintainability and safety) of this junction.

The layout was last renewed in 2003, see image 3. The main driver for the 2019 renewal was the poor condition of the ballast under the bearers; the bearer condition had started to deteriorate and the track quality was in the super red band.

The contract for the supply of the replacement layout for Newark flat crossing had been awarded to Progress Rail Services Limited.

AUTHOR



Phil Winship
Principal Engineer,
Asset Enhancement
Team, Track and S&C,
Safety, Technical and
Engineering
Network Rail

Chartered Mechanical Engineer and member of the IET

Joined the railway in 2002 on the Track Conversion Course as Railtrack transformed into Network Rail.

2002 – 2007 Spent 5 ½ years in track maintenance on the East Midlands.

2007 Moved to role of Senior Track Design Engineer within HQ Engineering.

2010 Transferred to the S&C team in engineering as Senior Engineer.

March 2018 – present. Joined the Asset Enhancement team on secondment as Principal Engineer.



Image 1: Newark flat crossing overview

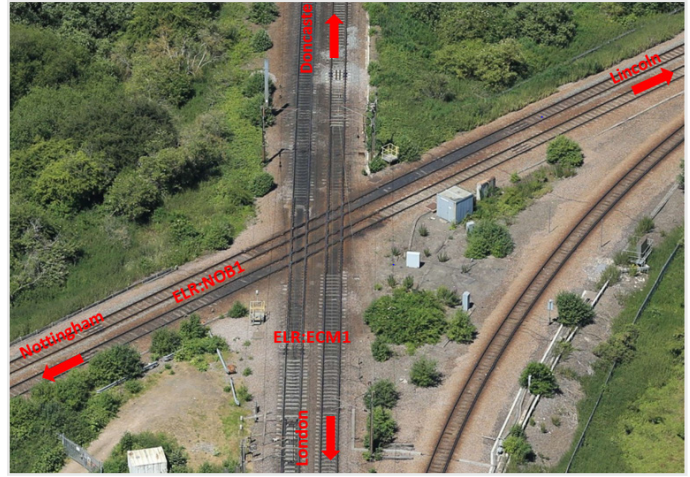

TRACK BED INVESTIGATION

As part of the preparation work for the renewal, an investigation of the track bed condition was carried out by the Network Rail Track Bed Investigation (TBI) team. See figure 3a and 3b.

The investigation included an assessment of the condition of the ballast and formation under the layout. This involved digging numerous trial holes and taking samples of the ballast and formation to form a picture of the condition of the site. The results from this work provided information that enabled an optimised track bed design to be developed for the renewal. The existing layout had geocells installed under the bearers and these were still in good condition. The new track bed design incorporated additional geocell sections that would increase the area of support under the layout and into the transition zones.

The TBI team also considered the effect of installing under bearer pads to the layout and how this might help increase the life of the ballast. They found that installing under bearer pads to the bearers could reduce ballast degradation over a 30-year period from 20 mm to 10 mm, see figure 4, prolonging the ballast life and reducing the rate of ballast degradation by around 90%.

The selected track bed design shown in figure 5 required.

- Under sleeper pads to reduce ballast deterioration, especially in the 'top' layer.
- Ballast compacted in two layers.
- Additional geocell layer on top of existing geocells to minimise ballast deterioration in 'bottom' layer.
- High accuracy of installation.
- Understanding that deterioration is expected as it is a ballasted system and settlement cannot be entirely eliminated.

It was anticipated that there would be a degree of settlement of the layout after the renewal which would need to be accounted for as part of the installation plan.

SOURCING THE BEARERS

Network Rail Route Services investigated the possibility of sourcing the replacement timbers required for the 16 m long bearers that were needed to make the bearer matrix. The problems with this were two fold.

- Greenheart timber was no longer FSC approved and therefore against Network Rail policy to use.
- The source of suitable timber was problematic due to civil unrest in Cameroon and other sources in Brazil not being able to supply the timber length required.

The lead time for the timber bearers (where available) was at least 18 months which would be well beyond the agreed possession dates

of August bank holiday weekend 2019. The possibility of specifying the bearers to be replaced using a composite alternative was then considered as a viable alternative to using timber.

I challenged the planned use of replacement timber bearers to avoid the problems of the previous layout and to look at alternatives such as a composite alternative. This eventually resulted in engaging with Sekisui regarding the supply of bearers made from fibre reinforced foamed urethane (FFU). Some FFU longitudinal bridge bearers had been supplied at trial sites in Southern region a few years previously, which had proven to be very successful.

There are a number of benefits in using the FFU material.

- The bearers can be made to any shape required.
- The FFU material has some similar properties to timber, ie it can be drilled or cut etc.
- It does not rot like timber.
- FFU has a potential lifespan of up to 50 years.

Agreement was reached with LNE route (now Eastern region) RAM(Track) engineers to change the bearers to the FFU material. Network Rail Track and S&C team within the Safety, Technical and Engineering Department

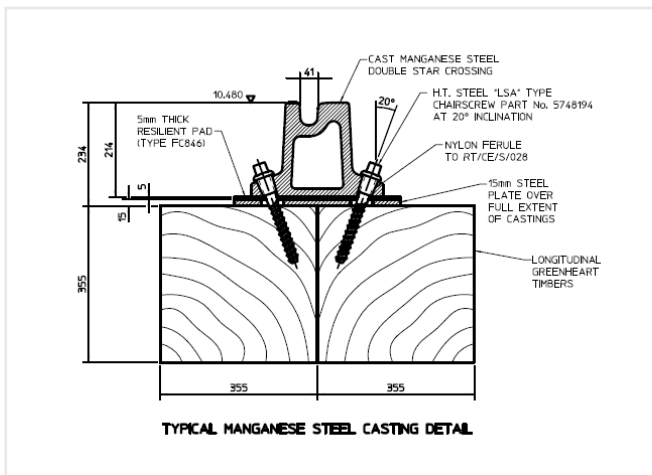

Figure 1: 2003 layout crossing fastening system.

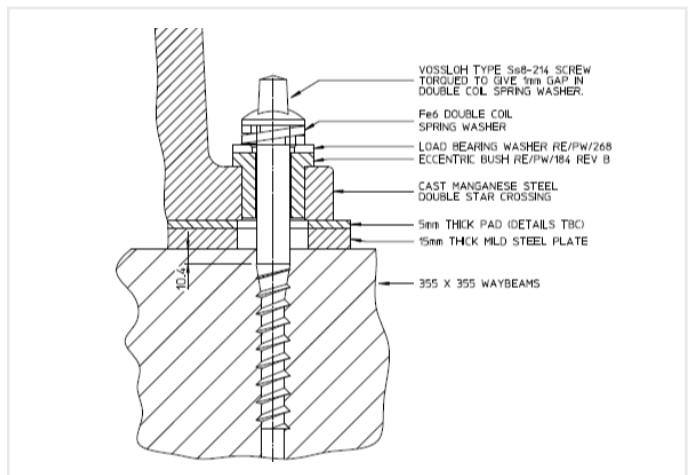

Figure 2: Revised crossing fastening system.

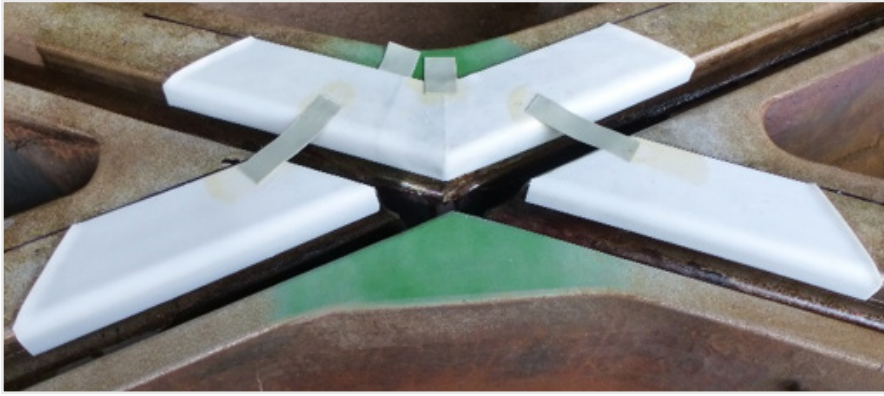
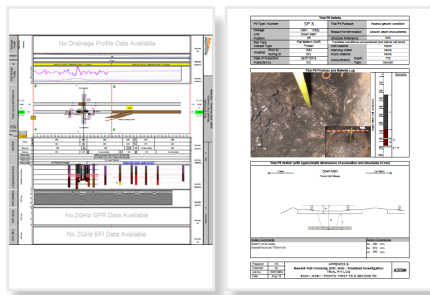

Image 2: Strips of explosive in place in preparation for EDH.



Image 3: The 2003 renewal being installed using a large road crane.



Figures 3a and 3b: Track bed investigation report extract.

(STE) would provide the engineering support to facilitate the manufacture and supply of the bearers with Route Services support.

The manufacturer (Sekisui) was very positive in being able to supply the bearers in an FFU composite form. However, one major problem quickly became evident; the Sekisui factory in Japan could only supply up to 10 m lengths due to factory size constraints, when the Newark layout required 16 m long bearers. In addition, the maximum length that could be transported by shipping container was also 10 m.

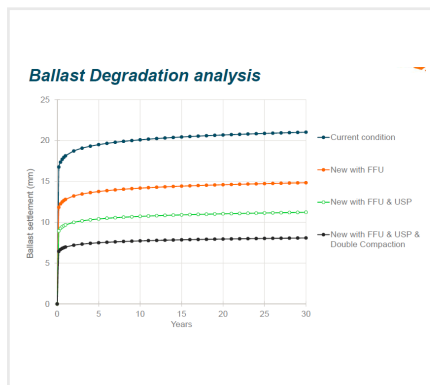

Figure 4: Ballast degradation analysis.

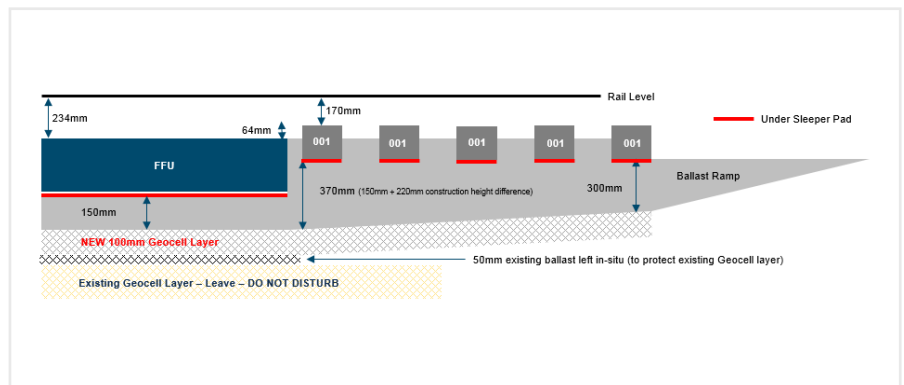

Figure 5: Selected track bed design.

The question of how we could overcome this problem involved further innovation, but this time not to the FFU product, but the physical production of the bearers.

The possibility of Progress Rail making the bearers in the UK with support from Sekisui was proposed. This was a very different challenge for Progress Rail as they had not manufactured anything like this before. After various discussions between Network Rail, Progress Rail and Sekisui, agreement was reached that Progress Rail would manufacture and assemble the bearers at one of their facilities in Derbyshire under the supervision of Sekisui engineers from the factory in Japan. This was the first time that any FFU bearers had been manufactured outside Japan by Sekisui.

Whilst the details of how the bearers would be manufactured in the UK was being agreed, the engineering drawings for the layout were drafted by Sekisui. These were submitted to NR and approved ready for the manufacture to commence in June 2019. Sekisui supplied all materials to Progress Rail, including the bearer small sections that could be pre-assembled at the factory in Japan. Progress Rail sourced clamps and other sundries in the UK to complete the tooling requirements for the assembly of the materials.

WHAT IS FFU ?

FFU is a material made from a glass fibre and polyurethane composite (figure 6). The material is manufactured by a pultrusion process in 30 mm thick lengths that are then layered to achieve the product height required. The layers are bonded together with an adhesive forming a very strong composite structure.

The material has the durability of a plastic, is a third lighter compared to wood, has workability properties similar to wood and has many other properties equal to or better than hard wood.

COMMON SAFETY METHOD - RISK ASSESSMENT (CSM-RA) FOR THE LAYOUT

The introduction of the FFU composite material for the bearer matrix of the layout was assessed as significant and agreed by NRAP (Network Rail Acceptance Panel) in accordance with CSM-RA requirements when introducing a novel material or component.

This was at odds with the CSM-RA submission to NRAP of Infrastructure Projects (IP)

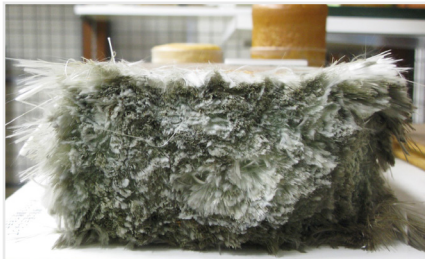
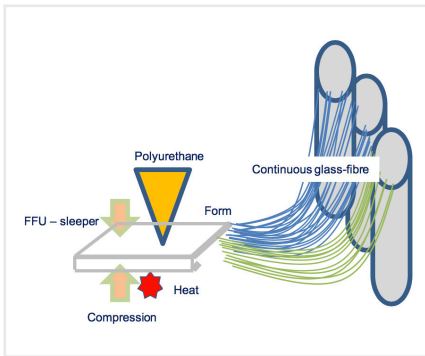

Figure 6: Pultrusion process and the finished material.

engineers for the layout. Their assessment was based upon the fact that the layout was being replaced as a like for like configuration, as the physical design of the layout was not changing.

The CSM-RA process was facilitated and followed by the STE technical lead engineer (myself) with support for IP and LNE route engineers. This involved appointing an independent Assessment Body (AsBo) to carry out an assessment of the evidence and documents required by the CSM-RA and to confirm the process had been correctly followed.

The CSM process involved a significant amount of work, involving many stakeholders attending various hazard identification workshops to work through identifying the hazards and risks of introducing the FFU composite material for this application. Anyone who has been through the full CSM-RA process will no doubt appreciate the amount of documentation this requires.

CONSTRUCTION AND ASSEMBLY OF THE BEARERS

The materials for manufacturing and assembly of the bearers were shipped over by Sekisui to the Progress Rail facility in Derbyshire and arrived at the end of May 2019.

The manufacture of the bearers in accordance with the NR approved engineering drawings commenced in early June 2019. This involved

E) Laminating on site in order to make one piece

Step1: Laminating FFU base plates for making one longer bulk

Step2: Laminating each parts which are produced in Japan on bulk or milling if possible

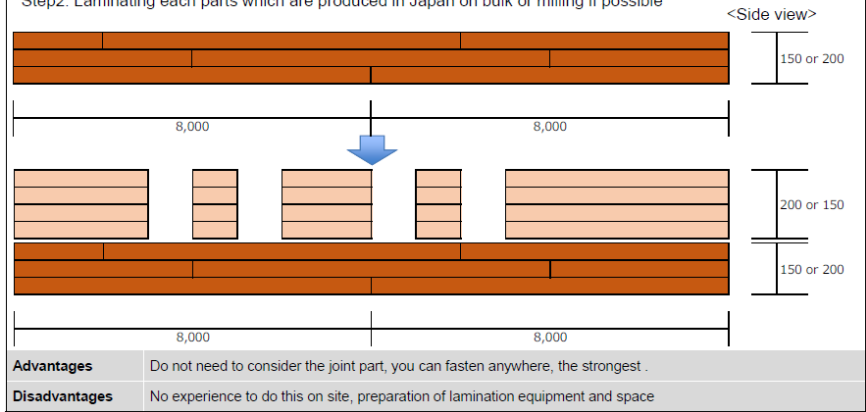

Figure 7: Cross-section of the FFU bearer.

the Progress Rail team assembling and gluing the 30 mm thick layers of FFU together in a lattice pattern under the supervision of Sekisui engineers to form the bearer lengths required (see figure 7).

The main body of the bearers was specified as FFU74 (740 kg/m³) with a top layer of higher density FFU 100 (100 kg/m³). This was to add further resilience to the bearer surface for possible long-term attrition from the crossing componentry. This work was made even more interesting as the Sekisui engineers did not speak English, so all communication had to be done through an interpreter. Despite this challenge, the Progress Rail team worked extremely well with the Sekisui engineers to make each of the bearers in the planned timescale.

Once the bearers had been successfully manufactured, see images 4a, 4b and 4c, the beams were assembled to form the bearer matrix for the layout. See image 5. It was decided, after consultation with the Sekisui engineers, to mirror the assembly of the timber bearers by adding bolts through the beam sections at the same positions as the previous timber bearers as an additional method of securing the composite layers together. This was in addition to the bolts that would be used to fasten the 16 joints where the bearers overlap.

The eagle eyed amongst you will have noticed that the FFU base material is a cream colour. Sekisui have a standard colour option for railway bearers; following the example of Henry Ford with the Model T, you can have any colour you like as long as it is muddy brown! The bearers were coated with a brown paint that is specified for use with the FFU. As you may expect you can't just use any paint as it needs to be compatible with the FFU material.

UNDER BEARER PAD

The track bed investigation considered the potential benefits of using under bearer pads (UBPs) in the assembly. The modelling of the whole system carried out by the TBI team, indicated an 88% improvement in ballast settlement rate using UBPs compared to a 42% improvement with FFU alone.

With the ballast life and condition being one of the drivers for the renewal, the decision to fit UBPs to the FFU bearers was not a difficult one. However, this did create a problem of the length and shape of UBP material that was required. This was resolved by using multiple lengths of UBPs for normal sized bearers to cover the whole surface area of the FFU bearers. Another 'small' issue was sourcing an adhesive that was compatible with both the FFU and the UBP material.

CAST MANGANESE DOUBLE STAR CROSSINGS

The design of the crossings was largely unchanged. However, this was reviewed to see where incremental improvements could be made. This focused largely on the fastening system, where possible changes were identified to improve the reliability and maintainability of the interface between the crossings and bearers. The changes to the fastening system built upon those made when the crossings were changed in 2105.

The main improvement was to remove the need for an eccentric ferrule as a component of the crossing foot fastening system. To do this the diameter of the hole drilled in the foot of the casting was reduced to be slightly wider than the adjacent screw shank. This has resulted in a much tighter tolerance between the crossing foot and screw shank dimension. The removal of the eccentric ferrule has also lowered the overall height dimension of the previous crossing foot/ferrule/screw combination. This has allowed an additional 10 mm of the screw shank to be in the bearer, improving the ability of the screw to resist lateral movement in service.

The removal of the eccentric ferrule also reduces the component inventory required to be available to maintain the layout. There are approximately 480 screw fasteners in the crossings of the layout.

Figure 8 shows the revised crossing foot fastener system that is now installed on the newly installed layout.



Images 4a, 4b, 4c: Manufacture of the FFU bearers.

EDH OF THE CROSSINGS

The intention was to supply EDH'd crossings for the renewal similar to the 2015 crossings previously installed. However, during the manufacturing of the first two crossings for the layout, some small cracks were found in one of the crossing noses after EDH had been carried out. See image 6.

The reason behind this was unclear at the time. There was a high risk that the other remaining six double star crossings could suffer the same problem if EDH was applied. There would not be enough time to produce additional castings and meet the timescales required by the project for the installation dates.

After discussions with the LNE RAM(Track) engineers and STE engineers, the decision was taken to accept the crossings without EDH being applied. This introduced the problem of managing the plastic flow of the crossing nose and wing rails during the initial few weeks of the layout being open to traffic.

Plans were put in place with the route engineers, STE engineers and Progress Rail, to periodically inspect the crossings after the layout had been opened to traffic and carry out any remedial work after each inspection. This has continued to ensure the crossing profiles

are maintained correctly as the work hardening process of the wheel/rail interface develops. Since the EDH cracking problem was found, Progress Rail have successfully identified and rectified a small number of issues that appear to have resulted in the crack propagation during the EDH process and a spare crossing has been manufactured without the defect developing.

DELIVERY OF THE LAYOUT TO SITE

The production and assembly of the layout in a warehouse, images 7a and 7b, confirmed that the bearer parts manufactured on site, the crossings and associated components all fitted together correctly. However, the assembly had to be transported to the site. This meant stripping everything down and transporting it to a rail head at Beeston to be transported to site by train. This was the only viable way of transporting the bearer sections to site as they were too long to transport by road as access to the site was very restrictive for loads of this length.

LIFTING OF THE BEARERS

The lifting and handling of the bearers was a key factor that needed to be considered at each point where the bearers needed to be moved. This was due to the interface

between the joints of each bearer section and the potential for the FFU to be damaged. A cautious approach was required as each bearer section was bespoke and would have been difficult to replace if any damage or distortion occurred.

The bearer unit is a matrix of overlapping double bearer sections. To enable the bearers to be moved to site, they had to be split down into the separate double bearer sections. These were easily lifted onto truck trailers at the warehouse site. There were two gantry cranes available to make sure the double bearer sections were lifted correctly without placing any stress on the sections that could deform or damage them.

Once at the rail head, the bearer sections were lifted from the trailers onto rail wagons by a Kirow crane using a spreader beam, see image 8a. This was also done to avoid placing stress on the bearers' sections and potentially damaging or distorting them which could have prevented them being reassembled successfully at the construction site. This lifting operation was repeated when the sections were unloaded at the site and the bearer matrix reassembled.

There was a concern that lifting the double bearer sections with straps wrapped around

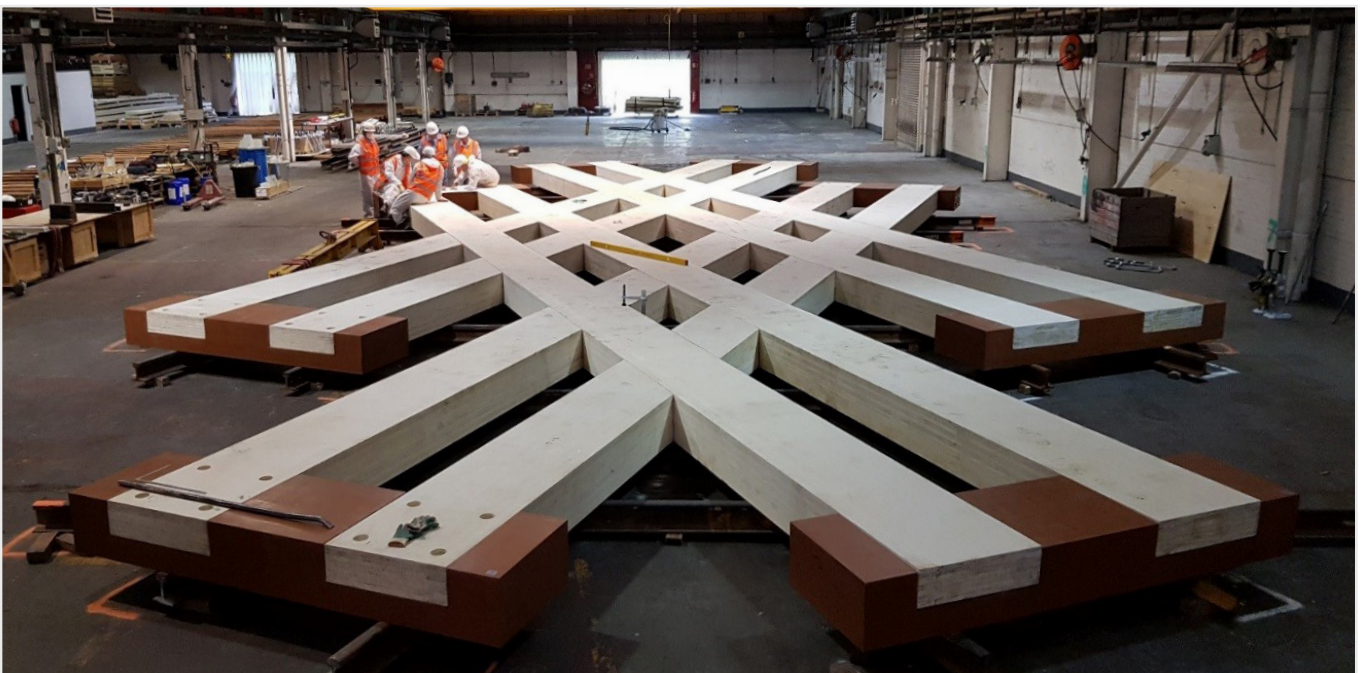

Image 5: The completed FFU bearer layout.

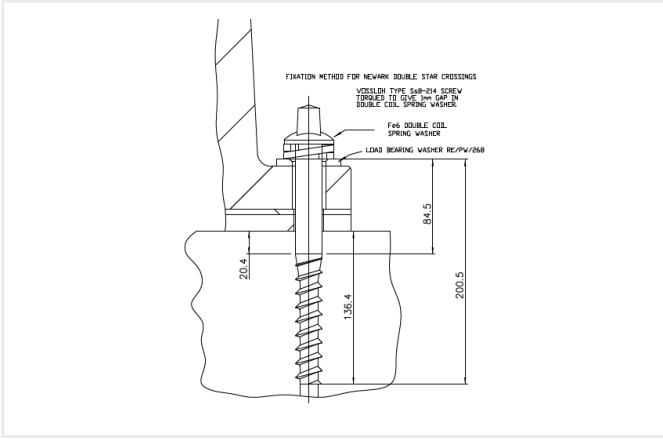

Figure 8: The crossing foot fastening system of the 2019 installation.

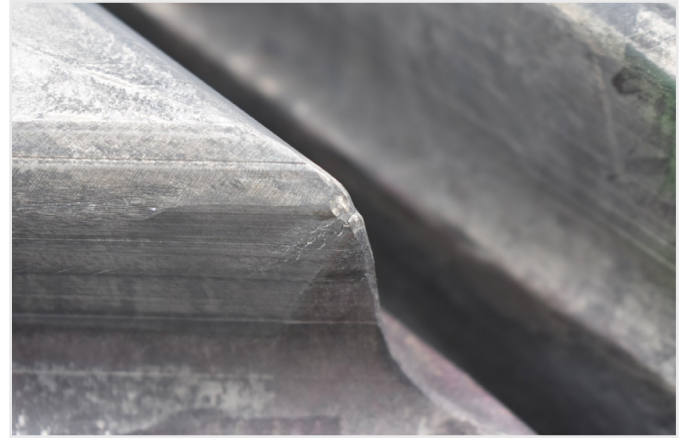

Image 6: Cracking on the crossing nose after EDH.

the whole section could potentially squeeze the two bearer lengths together which could distort or damage them. To mitigate against this happening, a wooden 'T' section spacer was made and placed in between each double bearer section during lifting operations. See image 8b.

ASSEMBLY ON SITE

To enable the layout to be assembled on site, additional work was required by the newly formed Central Rail Systems Alliance (CRSA) to create a flat build area where the components could be re-assembled. See images 9a, 9b and 9c. This involved unloading and levelling over 200 tonnes of spoil to create an area next to the junction that was at the same height as the adjacent track, which left quite an embankment! This was regraded after the completion of the renewal and the boundary fencing reinstated.

LAYOUT RE-ASSEMBLY

Once the site had been prepared the double bearer beams were delivered, unloaded and re-assembled (see image 10). The re-assembly of the layout was carried out by Progress Rail for the project. This made perfect sense as the Progress Rail team had assembled the layout in the warehouse, and so had the experience and technique of fitting it together again. They were also aware of the importance of the correct re-assembly of the composite bearers. Giving this task to the CRSA team would have added another risk to the project as they had no experience in assembling such a complex layout.

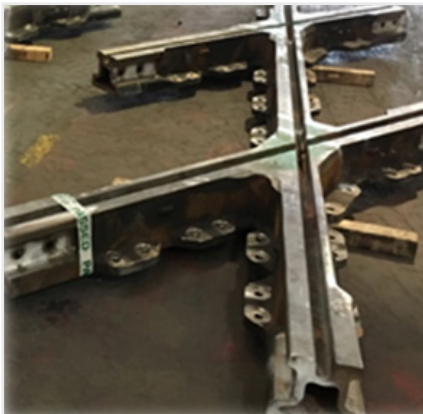

Image 7a: Double star crossing.

The full assembly of all the layout components was not possible before the bearers were taken to site because the holes for the bolts in the bearer joints could not be accurately drilled prior to the re-assembly of the bearers. This was because of the risk of misalignment of the holes in each half of each joint. Any misalignment of the bearers would result in the misalignment of the crossings, as they had been accurately assembled on the bearers prior to being dismantled for transport to site.

Each of the joints between the bearer sections was glued and bolted together using the same adhesive used to join the laminate sections together. Once the bearer halves were reassembled, the four bolt holes in each joint were drilled through the full joint section. During the construction of the assembly there were various stages where what might appear to be a simple decision to be made turned into a more complex issue to resolve. One such issue was the orientation of the through bolts in the bearer joint, 'bolt head up or bolt head down?'

The problem was that the bearers were 350 mm deep and the bolts were 320 mm in length. The bearers were placed on slave rails as is common practice when assembling a layout, however the rails are generally only 159 mm in height. So, you don't have to be a maths expert

to realise that getting a bolt in from under the bearer that is 320 mm long in a gap that is only 159 mm is not going to happen.

The shape of the recessed hole was also one of those 'detail' problems that needed to be resolved, as it would be very difficult to hold the head of the bolt underneath the bearer joint to stop it turning, whilst tightening the nut at the same time in a round hole.

This problem was solved by making a square shaped hole for a bespoke square shaped bolt head locking piece that sat under the bolt head and stopped the bolt head from turning when the nut was being tightened.

The bolt holes in the bearers were recessed to ensure that neither end of the bolt sat proud of the bearer surface. On the top of the bearers, this created a pocket for standing water to collect which was undesirable due to the potential for corrosion of the bolt to occur in the long term. To mitigate against this problem the bolts were torqued to the predetermined value for the FFU material properties and the recess filled with the same adhesive that was used to glue the laminate layers together. Inadvertently, this also acted as another locking mechanism for the torque prevailing type nut used.

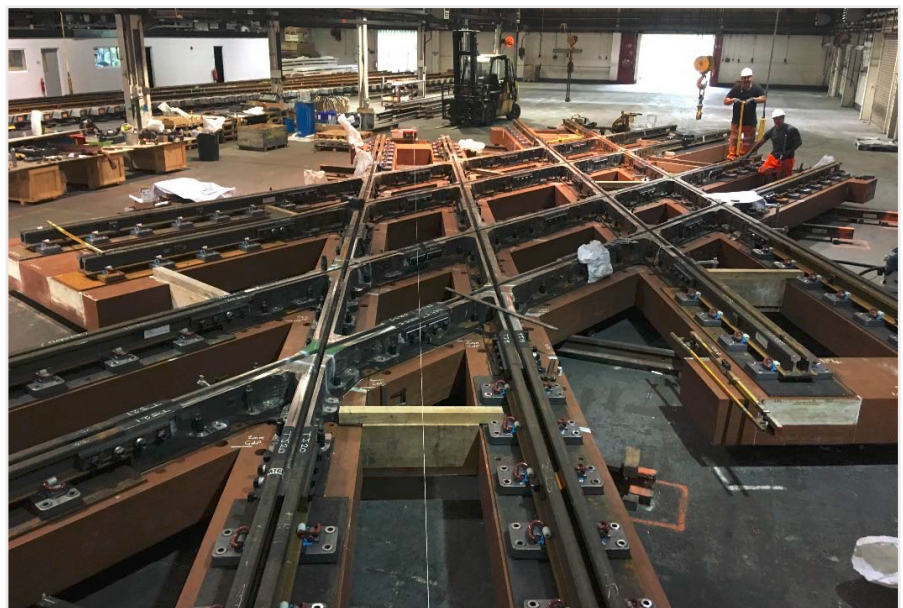

Image 7b: Installed on the layout.



Image 8a: Double bearer sections being lifted onto rail wagons.

The bearers were successfully assembled, and the crossings installed in place on top of the bearers in preparation for the layout to be installed.

Under each crossing is a bespoke 5 mm EVA pad and a 15 mm thick steel plate. The pad is the footprint of the crossing and the steel plate which has been kept from the last design to protect the bearer surface, extends wider than the crossing.

To simplify potential maintenance requirements, I took the decision to standardise the screw length throughout the whole layout. To enable this to be implemented a compromise had to be made with the baseplates on the check rail extension transition rails running on and off the crossings. Check rail baseplates from the NR56V S&C design were selected to be used which are made from a spheroidal cast iron.

This is a stronger cast iron than the previous grey iron check baseplates. The stronger cast iron baseplates enabled a higher toe load rail clip to be used, in this case a Pandrol® e-Plus clip. The higher toe load clip will help mitigate against rail movement due to seasonal ambient temperature variations.

The only difference to the standard UCV check baseplate that is used in NR56V S&C was that to enable the rail to be at the same height as the double star crossings running surface



Images 9a, 9b, 9c: Build area created next to the junction.

the UCV baseplate rail seat needed to be thickened, see image 11.

PRODUCT ACCEPTANCE

The product acceptance requirements for the new layout needed primarily to consider the new use of the FFU composite material for this bespoke layout.

Those in IP who needed to ensure that the layout had a PA certificate in place, were a little nervous that the certificate was not signed off by the Professional Head of Track until two weeks before the installation. I had made it clear to the lead project engineer that this would be the case early in the project. He was happy with my reasoning and understood why this would be the case. This was because until the bearers had been fully constructed and each of the joints glued and bolted together successfully, from an engineering risk point of view, I was not prepared to accept the PA certificate was ready to be signed off. The risk was still very real that there could be a problem with the re-assembly of the bearers and especially the joints on site. This confirmation clearly could not have been carried out when the bearers were assembled in Progress Rail's warehouse as they needed to be dismantled and transported to site. The final assembly inspection could only take place at the build site.

LINESIDE ASSEMBLY COMPLETION

The hard work from the Progress Rail team who re-assembled the layout is clear to see as shown in image 12, with the layout completed and ready for installation on time.

During one site visit I made to check on progress and the joints for the PA certificate,



Image 8b: The spacer block.

with the Progress Rail team lead, I had one of those conversations where for a split second panic and doubt enters your mind. The conversation went something like this; 'Phil, you know something, I'm not sure the angle of the bearers is right. Comparing that with the one in track, Hmmm.... not sure it'll fit!'.

After quickly composing my mind, I assured him that the new crossings were exactly the same footprint as the one installed, so as they fit exactly on the new layout, I am sure the bearers are right shape and angle.

CORE WORKS – THE INSTALLATION

The planned possession for the installation of the layout was over the August bank holiday weekend (25 - 27) 2019. This just happened to be the hottest weekend of the year with ambient temperatures reaching 33°C.

THE PLANNING

The method and process of removing the old layout and installing the new layout had been meticulously planned by the Central Rail Systems Alliance.

The method of removing the old layout and installing the new layout was to be carried out using two Kirov 250 cranes. The main advantage of using the rail mounted cranes was that they could operate under the overhead line equipment (OHLE).

This saved a significant amount of possession time that would have been required for removing and reinstating the OHLE as well as the resultant disruption. This also introduced other challenges such as a tandem lift with a 52 tonnes unusually shaped layout.

The plan for lifting the layout involved moving it from the assembly area to a holding area north





Image 10: Bearer beams being unloaded and re-assembled on site.

of the Newark – Lincoln line and then lifting it into place. The outline plan for the tandem lift shown in figure 9 indicates the three steps to the installation lifts.

TEMPORARY SLAVE PANEL

Temporary slave rail panels were needed to be used during the works to allow the cranes to manoeuvre the layout into position.

Due to the depth of the bespoke bearers (350 mm) combined with the additional height of the crossings, the new ballast bed was much lower than usually found on a track renewal. This meant that a simple short panel of track would not be suitable as the height difference between that and the crossing/bearer layout would be significant.

To resolve this issue a bespoke slave panel design was used with triple depth timber sleepers to bring the height of the slave panels into line with the layout height. This can be seen in the diagram and photo of a slave panel (figure 10).

REMOVAL OF THE OLD LAYOUT

After being installed for over 16 years and given the traffic tonnage that had passed over the junction, the ballast around the bearers of the layout was very well consolidated. Adding to the ballast compaction that had occurred over that time, the ballast had also been glued. This made extracting the old bearer assembly quite difficult as until you start removing this there was no way of knowing exactly how this would go.

The 'old' crossings were removed and retained for use as maintenance spares before the bearer matrix was cut into two sections to make their removal easier (image 13).

LIFTING THE LAYOUT INTO PLACE

The lifting of the layout was carried out by the two Kirow 250 rail cranes in a tandem lift. One problem that we needed to understand during the lift planning stage was what the proposed lifting method would be? By that I mean the lifting points on the layout. How many would there be and where would they be? The ideal situation would be to use a spine beam and have multiple lifting points, therefore

supporting the layout evenly across the whole area of the bearers. This was not possible with the planned tandem lift with Kirow cranes. The compromise was to use a small 'connection' beam on each crane and place straps around two of the north and south joint clusters. Figure 11 shows the layout lifting points that were used.

This then raised the question of what stress would be placed on the components and would the FFU bearers be able to withstand these? Complex calculations were carried out to understand the values involved and if there was a risk of damage occurring to the FFU bearers. These considered the stress that would occur in the bearers alone. The addition of the stiffening effect of the crossings was not included in the calculations but it was taken into account that the 8 double star crossings fastened to the top of the bearers would significantly stiffen the whole structure. The calculations considering the bearers alone, confirmed there was a factor of safety of at least 2.5, but this would be greater when considering the effect of the crossings being in situ. The conclusion was that there was little risk of the FFU bearer assembly being damaged during the lifting operation.

Another problem was the possibility of crushing the FFU at the point of contact between the straps and bearers. To mitigate against this 100 mm wide straps were used at each lifting point to spread the load as much as possible. The straps were sacrificial and were cut off once the layout was in place.

THE LIFT

The plan for the lift was for both cranes to be on the Down EMCL and then to lift the layout, bring it into line with the track and then traverse north to the holding point in preparation for the second lift, placing the layout in its final position.

The first lift started well but once the jibs of each crane moved toward the track centre line, the position for the centre of gravity shifted, causing the layout to develop a very heavy list. This was definitely a heart in mouth moment. Once the lift had started there was little opportunity to place the layout down again until it reached the holding area.

Fortunately, the layout was successfully moved, if in a rather ungainly way, to the holding area without further incident (see image 14). The layout needed to be placed in the holding area to allow a slave panel that allowed one of the cranes to pass over the 'hole' where the old layout had been to be removed. The layout was then lifted into place and then 'inched' into its final position.

Asking a Kirow crane driver to move the jib position a few millimetres here and a few millimetres there is quite a big ask. But after a bit of adjusting it was set in its final position (images 15a, 15b and 15c).

After each lift, myself and a colleague inspected the bearers to confirm no damage had occurred to the FFU material or the bearer



Image 11. Check rail extensions with thickened UCV rail baseplates and Pandrol® e-Plus clips.



Image 12: The assembled layout awaiting installation.

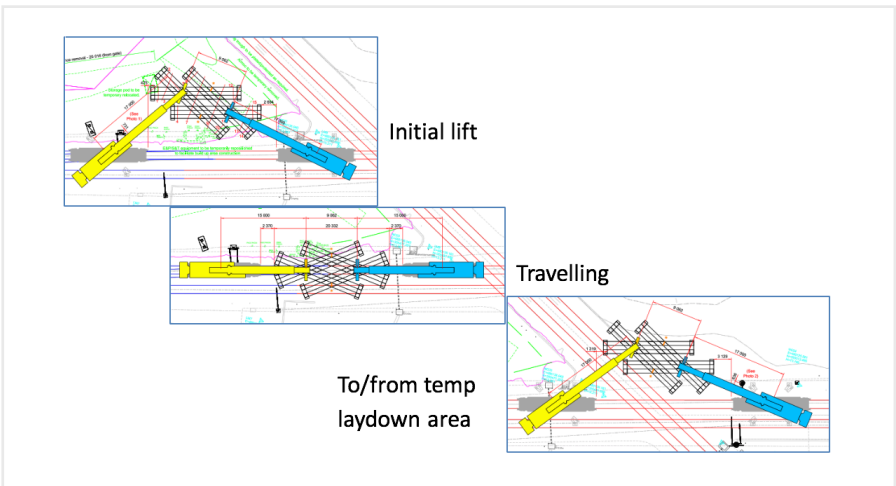

i TEMPORARY SLAVE PANEL

This is a temporary track panel that is constructed and taken to a renewal site that can be used to fill a gap where track has been removed but rail vehicles need to travel over the area of removed track. Once the required rail vehicle manoeuvres have been completed, the temporary slave panel is removed, and the new track installed.

Figure 9: The Kirow crane lifting stages.

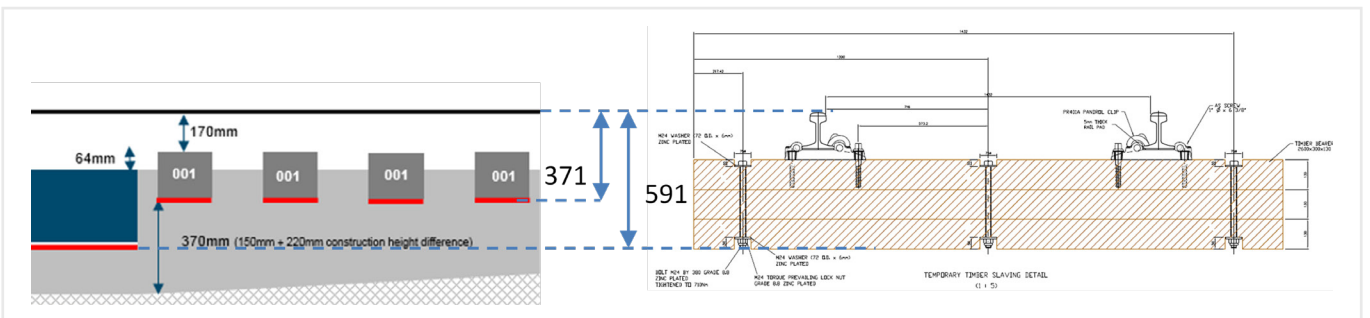

Figure 10: Slave panel design to level rail heights during the installation.



Image 13: One half of the old bearers being removed.

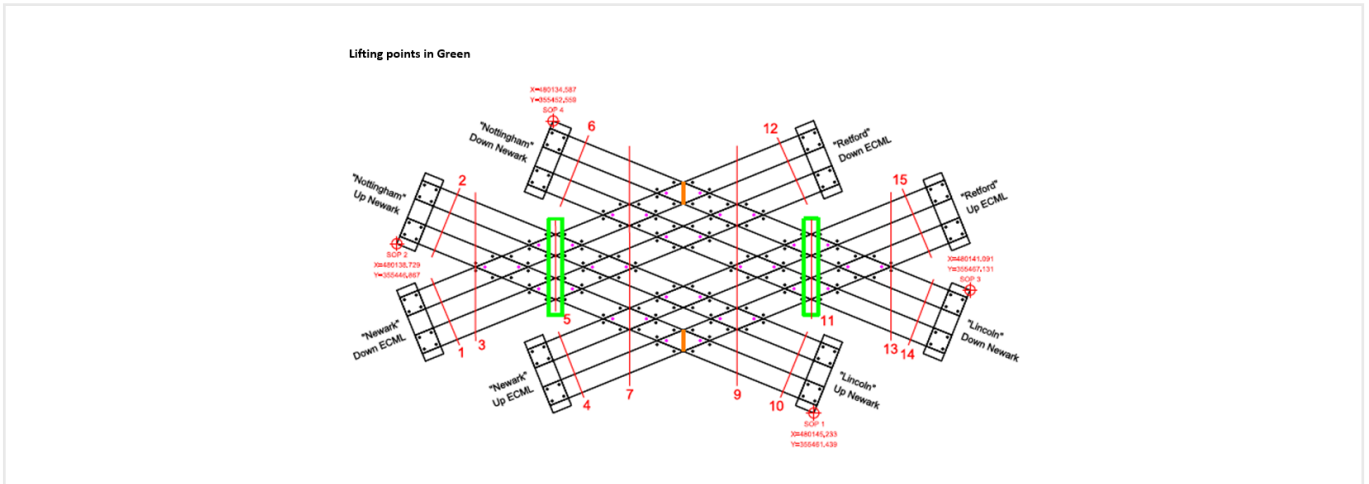

Figure 11: The layout lifting points.



Image 14: The layout being moved to the holding area.



Image 15a (top): The layout in position. Image 15b (bottom): Tamping. Image 15c (next page, top left) Ready for handback.



construction. Despite the stresses that had been placed on the bearers during the lifts, no distortion or structural damage had occurred. The only damage found was some light crushing of the bearer corners where the lifting straps had been placed.

OPEN TO TRAFFIC AND POST WORKS

Thanks to the great work of the Central Rail Systems Alliance, both lines were open on time with a TSR of 50 mph.

The layout had been installed 15 mm high, to take into account ballast settlement in the first few weeks of traffic. It was easier to grade in the transitions to a 'high' layout rather than lower everything because the layout had sunk due to settlement. Once the layout was in place there was no possibility of going back to lift and pack it.

After two weeks an inspection took place to check the condition of the bearers and crossings. If you remember, these were not EDH'd and were therefore expected to plastically deform during the first few weeks of traffic until work hardened. Sure enough, the crossing noses and wing rails had deformed

and needed to be ground to correct their profiles, which was carried out on the same weekend by the local welding manager and his team. It was also evident during the inspection that voiding had developed at various locations under the bearers. This was rectified during the same weekend using Robel hand tampers which proved extremely effective.

The linespeed on the ECML was raised to 80 mph (the linespeed on NOB1 is 50 mph) and after a further follow up inspection two weeks later by engineers from STE, CRSA, LNE (now Eastern Region) and the local TME, the linespeed was restored to 100 mph.

TRACK QUALITY

The track quality after the initial track recording run showed the ECML 1/8th of a mile the junction is in to be a super-red. This was a little disconcerting, but when you then factor in that this was before the hand tamping had been carried out, it was not too surprising. The next recording after the hand tamping showed a huge improvement bringing the track quality into the satisfactory band.

Those sceptics amongst you may feel that is not where it should be, after all it's a brand-new layout. However, when you consider the number of discontinuities that are present in that 1/8th mile it is not a bad result:

- an under bridge over the river Trent to the north
- the northern set of adjustment switches
- the flat crossing (8 crossing noses (per track) within a few metres)
- the southern set of adjustment switches
- a crossover to the south
- an overbridge to the south.

An MST (maintenance scheduled task) continues to be in place to ensure the crossings are regularly inspected by the local welding manager and any small developing

defects are repaired early, preventing major disruption caused by larger defects and ensuring this important junction is well maintained.

The FFU bearers are currently inspected during the same visits by a STE engineer to confirm they continue to perform well. The University of Southampton has been engaged by STE to periodically monitor the layout with a sensor system to help gather data to further understand the performance of the FFU bearers. This monitoring will cover a full 12-month period since the renewal.

Some of those engineers who regularly travel by train over the flat crossing (see image 16) have commented to me that they always knew when they were going over the old layout, but now they are hard pressed to notice they've gone over the crossings..... Job well done!

ACKNOWLEDGEMENTS

Nigel Keightley; Senior Engineer, Eastern Region RAM(Track) team, Network Rail – the customer.

Steve Varley; Project Engineer, Infrastructure Projects, Network Rail – the project engineer. Mark Smith; Lead Engineer, Infrastructure Projects, Network Rail – led the installation). Dave Peet; Principal Engineer Track, Progress Rail Services Limited – the layout design engineer.

Kev King; Team leader; Progress Rail Services Limited – led the team that manufactured the FFU bearers and assembled the layout.

Günther Koller; Sekisui Engineer - engineered the bearers

Levente Nagy; Senior Design Engineer, TBI team, Network Rail – track bed investigation

Without the teamwork of the individuals above and others (and their respective teams) it would not have been possible to deliver this project.

My heartfelt thanks to all of you.



Image 16: A new Azuma train passing over the new flat crossing layout.

TECHNICAL ARTICLE

AS PUBLISHED IN

The PWI Journal
April 2020

VOLUME 138 PART 2

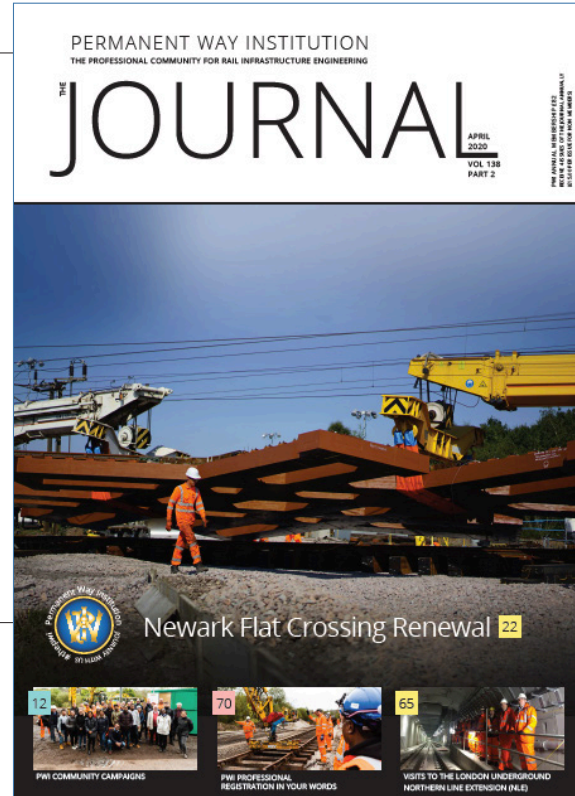

#thepwi

W thepwi.org

f [PermanentWayInstitution](https://www.facebook.com/PermanentWayInstitution)

t [@PermWayInstit](https://twitter.com/PermWayInstit)

in [Permanent Way Institution](https://www.linkedin.com/company/permanent-way-institution)

i [@the_pwi](https://www.instagram.com/the_pwi)



If you would like to reproduce
this article, please contact:

Kerrie Illsley
JOURNAL PRODUCTION EDITOR
Permanent Way Institution
kerrie.illsley@thepwi.org

PLEASE NOTE: Every care is taken in
the preparation of this publication, but
the PWI cannot be held responsible
for the claims of contributors nor for
the accuracy of the contents, or any
consequence thereof.